

# PM5A3

---

*5 kV Digital insulation tester*

## User guide

GF-2120

© 2021 Phenix. All rights reserved.



## Safety warnings









- Before to use this instrument the User guide and Safety warnings must be read and understood.
- Safety procedures and rules for working near high voltage energized systems must be observed during the use of this equipment. The generated voltages may be dangerous.
- Do not connect or disconnect the test leads during the measurement.
- Do not touch the test leads before the high voltage indicator turn-off.
- Be careful not to make short-circuit between the high voltage terminals and the “R” or “Guard” terminals while a measurement is running, because it could be dangerous for the operator.
- Be sure that there are not any voltage difference between the points to which the equipment will be connected to, neither between them and ground.
- The panel, terminals and connectors of the equipment must stay dry and clean.
- Use only accessories / replacement parts provided by the manufacturer.

---

**This equipment should be used only by a trained and competent person, strictly applying suitable safety rules.**

---

## Used symbols

	Caution, risk of electric shock.
	Caution, refer to User Guide.
	Equipment complies with current EU Directives.
	Battery
	Printer
	Double insulation
	Backlight
<b>CAT III</b>	Measuring category III
	The rubbish bin with a line through it means that in the European Union, the product must undergo selective disposal for the recycling of electric and electronic material, in compliance with Directive WEEE 2002/96/EC.
	Do not use in distribution systems with voltage higher than 660 V (phase to phase)

## **Measurement Categories (CAT)**

### **CAT II - Measurement Category II**

Corresponds to measurements taken on circuits directly connected to low-voltage installations.

### **CAT III - Measurement Category III**

Corresponds to measurements on building installations.

### **CAT IV - Measurement Category IV**

Corresponds to measurements taken at the source of low-voltage installations.

# Index

1. Description.....	9
2. Panel control functions.....	10
2.1. Keyboard.....	11
2.2. Display.....	13
3. Battery charger.....	14
4. Connecting the PM5A3.....	15
4.1. Use of “Guard” (G) terminal.....	17
5. Setting tests.....	18
5.1. Navigating the MENU.....	18
5.2. Setting the measurement modes.....	19
5.2.1. Manual mode.....	19
5.2.2. “TIMER” Mode.....	19
5.2.3. Step Voltage Test (SVT).....	21
5.2.4. Ramp mode.....	23
5.2.5. Common parameters.....	24
5.2.5.1. Minimum resistance (pass / fail mode).....	24
5.2.5.2. Maximum voltage.....	25
5.2.5.3. PI – Polarization Index.....	25
5.2.5.4. DAI – Dielectric absorption index.....	26
5.2.6. Dielectric Discharge.....	27
5.2.7. Capacitance Test.....	28
5.3. Equipment setting.....	29
5.3.1. Language setting.....	29
5.3.2. Setting the date format.....	29
5.3.3. Time Format Setting.....	30
5.3.4. Setting the date.....	31
5.3.5. Setting the time.....	31
5.3.6. Selecting the interaction with the backlight.....	32
5.3.7. Adjust the backlight.....	33
5.3.8. Equipment Information.....	34
5.4. Memory.....	35
5.4.1. Memory usage.....	35
5.4.2. Delete.....	35
6. Performing tests.....	36
6.1. Manual Testing.....	36
6.2. “TIMER” Mode.....	38
6.3. Step voltage test (SVT).....	39
6.4. Ramp test.....	40

6.5. “Pass / Fail” Test mode.....	41
7. Other functions.....	42
7.1. Backlight.....	42
7.2. Filter.....	42
7.3. True RMS AC/DC Voltmeter.....	42
7.4. Leakage current measurement.....	42
7.5. Hold.....	42
7.6. Battery status check.....	43
7.7. Auto power-off.....	43
8. Software.....	44
8.1. USB Drivers.....	44
8.2. PXLogger software.....	44
9. Remote control.....	45
10. Printer.....	46
11. Cleaning.....	46
12. Technical Specifications.....	47
13. Application note 32.....	50

## 1. Description

---

The digital insulation tester model **PM5A3** is Phenix cutting edge insulation analyzer equipment and it is one of the most complete and sophisticated available in the international market. Its proven technology provides safe, reliable and accurate measurements of insulation resistances up to 5 TΩ, with 4 pre-selected test voltages, 500 V - 1 kV – 2.5 kV - 5 kV. Other test voltages from 50 V to 5 kV, can be selected in steps of 25 V or 500 V.

A state-of-the-art microprocessor controls the equipment operation and enables the incorporation of advanced features which make measurements easier: auto-range selection, 16000 readings memory, AC/DC voltmeter, automatic measurement of Absorption Index and Polarization Index, leakage current and capacitance measurement, timer enabling programming of test duration, configurable Pass-Fail test, Step voltage test, real time clock and calendar. Built-in chronometer, indicating elapsed time, in minutes and seconds, since the test started.

Measured values are transmitted through the USB interface and are printed in the built-in printer as a registration of the performed test. Furthermore, the measured values are stored in a non-volatile internal memory. The PXLogger program allows a further analysis of the test results, including a graphical representation and automatic report generation. The real time clock and calendar, and the sequential test number, facilitates the identification of each test, and the organization of a predictive maintenance system by trend analysis. The **PM5A3** is powered using a rechargeable battery and the cabinet is strong and lightweight, easy to carry, impact-resistant and suitable to be used under severe weather conditions. Thus the insulation tester supplies very reliable and accurate measurements both in laboratory and out in the field.

## 2. Panel control functions

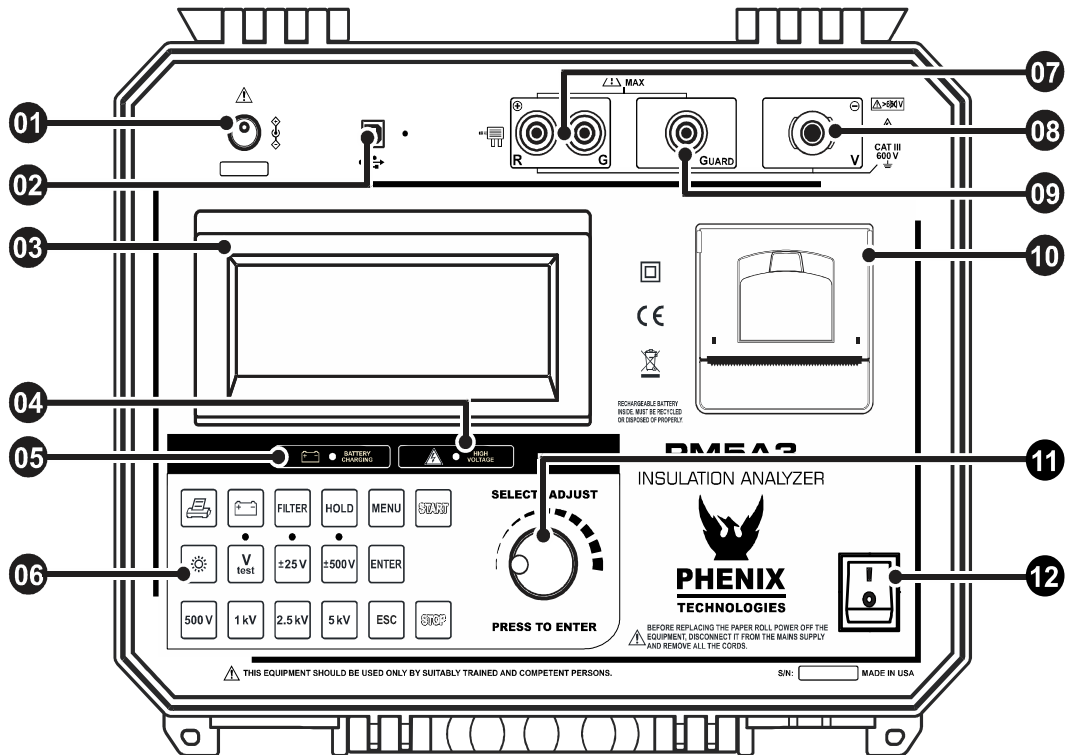







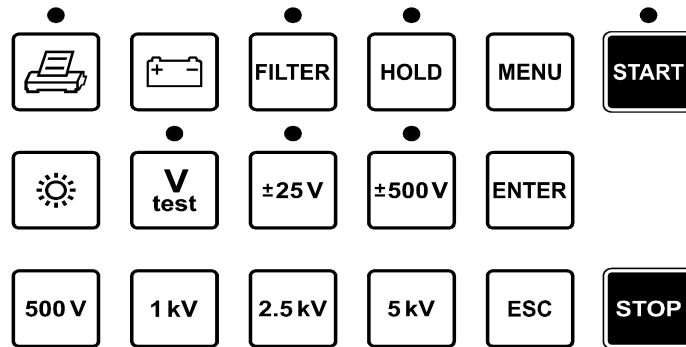











- |    |                        |    |                              |
|----|------------------------|----|------------------------------|
| 01 | Power supply input     | 07 | Zero reference terminal (+R) |
| 02 | USB communication port | 08 | Voltage output terminal (-V) |
| 03 | Display                | 09 | Guard (G) Terminal           |
| 04 | High Voltage led       | 10 | Printer                      |
| 05 | Battery charge LED     | 11 | Voltage adjust control       |
| 06 | Keyboard               | 12 | On / Off key                 |



## 2.1. Keyboard



Key	Function	LED
	Turns the printer on/off	Indicates that the printer is turned on
	<b>Hold</b> - Freeze the last reading on the display	The Hold function is on
	<b>Battery</b> - exhibits the battery charge status on the display	—
	<b>Filter</b> - Activates the filter that minimizes the interference of the external noise	Indicates that the filter is on
	<b>Backlight</b> - activates the display light	—
	When activated it allows to select the test voltage	Test voltage can be changed
	Activated, enables programming of 25 V step tests voltages	25 V steps activated
	Activated, enables programming of 500 V step tests voltages	500 V steps activated

	Selection of 500 V test voltage	—
	Selection of 1 kV test voltage	—
	Selection of 2.5 kV test voltage	—
	Selection of 5 kV test voltage	—
	Allows access to the equipment configuration MENU	—
	<b>Start</b> - Start test	Indicates that the test is being executed
	<b>Stop</b> - End of test	—
	Open the selected submenu / confirms the configured value	—
	Cancel setting and return to previous screen	—
	Navigate between the MENU options, adjust the set parameters, adjust the test voltage (in Manual Test and Timed modes).	—

## 2.2. Display

Measurement results in the corresponding measuring unit, elapsed time since the measurement started, selected test voltage and several messages to the operator are displayed on alphanumeric LCD.

Below is an example of the display information, in this case, this is the initial screen of the equipment ready start a measurement.

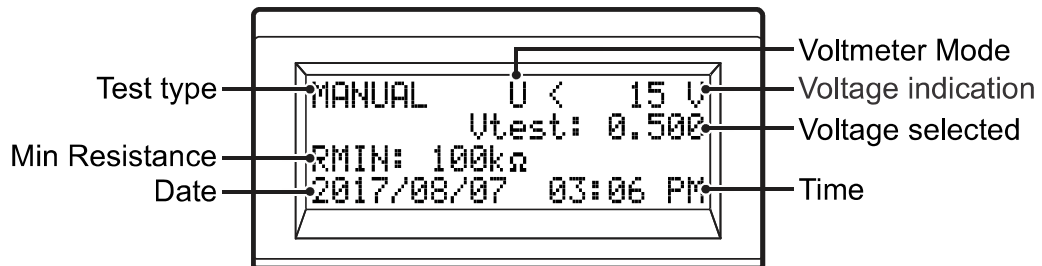

### 3. Battery charger

---

The **PM5A3** uses a rechargeable LiFePO4 12 V - 6000 mAh battery.

#### **Charging procedure:**

- Check if the **PM5A3** is turned-off and connect it to the mains (AC adapter).
- The charging indicator (  ● **BATTERY CHARGING** ) will turn on red and will remain that way until the battery is totally charged. Then the light will remain green and keep in that way until the **PM5A3** is disconnected of the mains.



Use only the AC Adapter provided by the manufacturer. The use of any other AC Adapter may compromise the equipment safety.

---

---

This equipment uses a smart battery with overcurrent and overload protection. Therefore, it may occur that in situations of high voltage sparking, the battery will protect the equipment disarming the system. To reassemble the system is necessary charge the battery for a few seconds.

---

---

**Perform a full charge cycle before using the equipment for the first time, or after a period without using the equipment (The battery loses some of its charge being stored).**

The rechargeable battery does not have “memory effect” and there are no restrictions to start charging it as many times as is needed. Charge the battery before left the equipment in storage and don't let pass more than 30 days without recharge.

---

---

**IMPORTANT:** If, during the battery charge, the equipment is turned ON, the charge will be momentarily interrupted, returning to the charge process once the equipment is turned OFF.

---

## 4. Connecting the PM5A3

---

**ATTENTION:** For a safe operation, the procedures detailed below should be carried out with the device Powered-Off.

---



Use only the accessories / test leads supplied by the manufacturer. Using accessories / test leads not provided by the manufacturer may compromise the equipment safety.

---

Please, do check there is no difference of potential voltages between the points where the **PM5A3** shall be connected to. Please, check the same between those points and the ground.

At the time of the connection and power-on, the equipment automatically enters in the voltmeter mode and begins to exhibit the circuit voltage in the display.

The circuit to be tested must be de-energized to avoid interference in the measurement. The equipment will block the start of measurement if it detects a voltage greater than 60 V in the circuit.

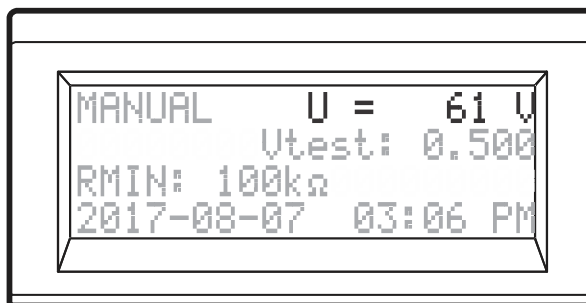

Connect the red cable security terminal to the equipment **(-V) output terminal**, the terminal of the black cable to the **zero reference (+R)** terminal and the “alligator” terminals to the element to be measured as indicated in the next figure.

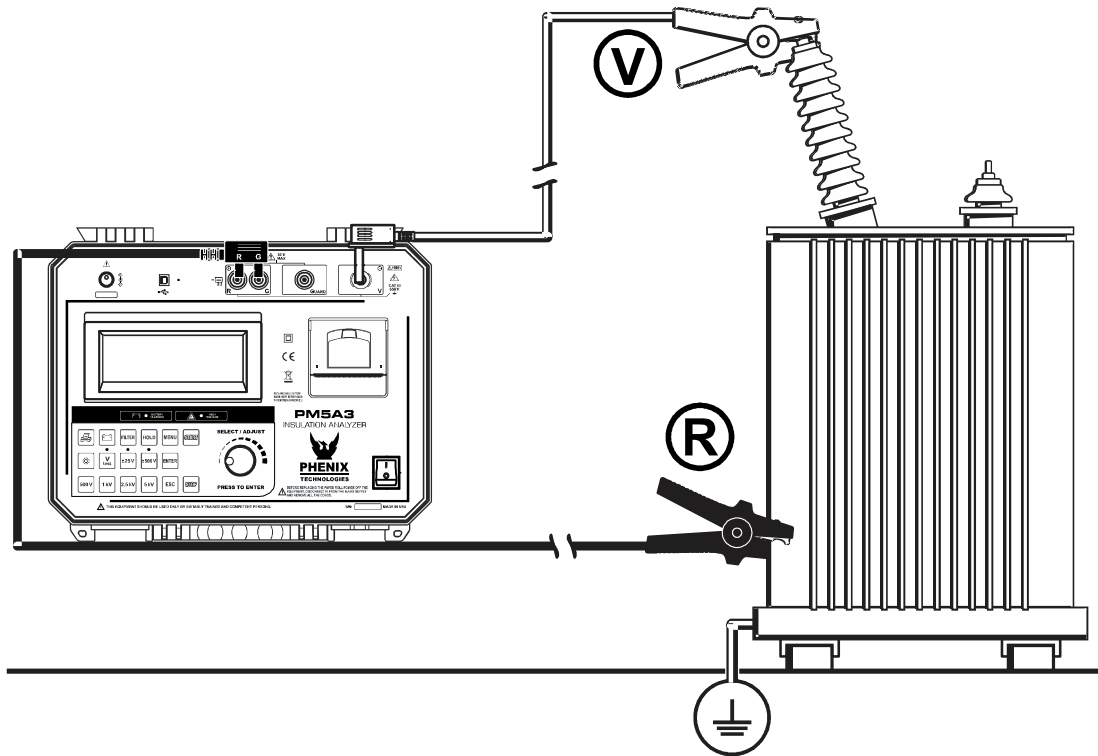

The test leads in the picture are merely illustrative.

## 4.1. Use of “Guard” (G) terminal

Depending on the measurement to be made, the **Guard (G)** may be used or not. During the measurements, the equipment should be electrically grounded to avoid unsteady readings. When insulation is measured regarding grounding, the **R** terminal is connected to earth and the condition by means of which the equipment potential setting is fulfilled. If the measurement is performed between two parts, which are not grounded (for example, between two phase conductors in a three-phase cable), the equipment *GUARD* terminal must be grounded. This implies that **whenever a measurement is performed, one of the GUARD or R terminals must be grounded, but not both of them simultaneously.**

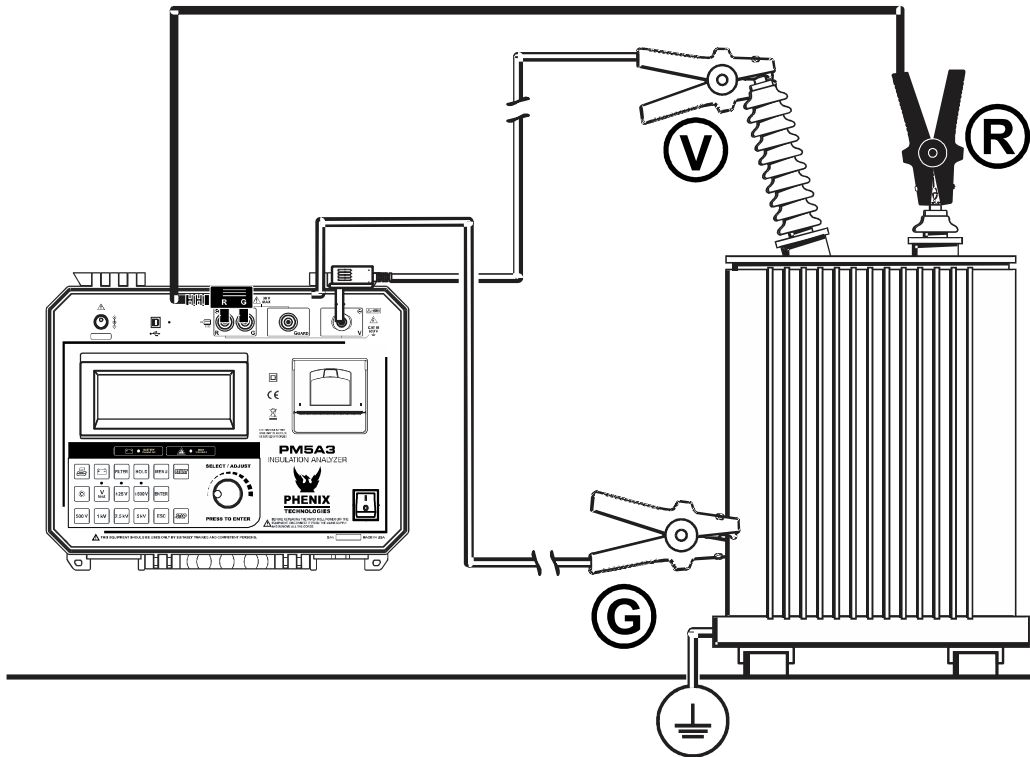





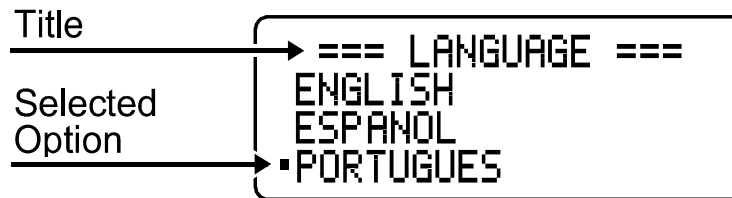
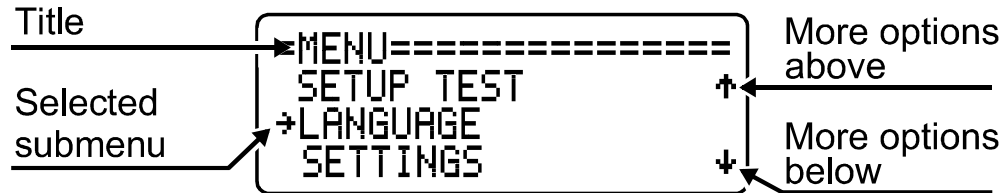

The test leads in the picture are merely illustrative.

Technical Note 32, reproduced at the end of the manual, explains the usage of GUARD terminal in order to eliminate the parasite resistance effect over the result of measurements.

## 5. Setting tests

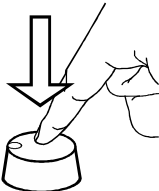
### 5.1. Navigating the MENU





	Open MENU
	Change selection / values
	Open MENU, open selected sub-menu / confirm edition
	Open selected sub-menu / confirm edition
	Cancel
	Cancel and close the MENU



## 5.2. Setting the measurement modes

### 5.2.1. Manual mode

- Access the device's MENU using the  button.
- Use the control , select the SETUP TEST option and press .

```
=MENU=====
MODE SELECTION
➔SETUP TEST
LANGUAGE ↓
```

- Use the control , to select MANUAL TEST and press .



```
=SETUP TEST=====
➔MANUAL TEST
TEMPORIZED TEST
STEP VOLTAGE TEST ↓
```

### Parameters

```
=MANUAL MODE PARAM==
➔MINIMUM RESIST.
MAXIMUM VOLTAGE
PI ↓
DAI
RETURN
```

- **Minimum resistance**  
(See 5.2.5.1, pg. 24)
- **Maximum voltage**  
(See 5.2.5.2, pg. 25)
- **PI – Polarization index**  
(See 5.2.5.3, pg. 25)
- **DAI – Dielectric absorption index**  
(See 5.2.5.4, pg. 26)

### 5.2.2. “TIMER” Mode

- Access the device's MENU using the .
- Use the control , select the SETUP TEST option and press .

```
=MENU=====
MODE SELECTION
➔SETUP TEST
LANGUAGE ↓
```

- Use the control , select the TEMPORIZED TEST option and press



```
=SETUP TEST=====
MANUAL TEST
+TEMPORIZED TEST
STEP VOLTAGE TEST ↓
```

### Parameters

```
=TEMP MODE PARAM====
+MINIMUM RESIST.
MAXIMUM VOLTAGE
DWELL TIME ↓
```

```
PI
DAI
RETURN
```







- **Minimum resistance**

(See 5.2.5.1, pg. 24)

- **Maximum voltage**

(See 5.2.5.2, pg. 25)

- **Dwell time**

Use the control , select the DWELL TIME option and press . Use the control  to set the time in minutes and press . Use  to set the time in seconds and press  to confirm or  to cancel.

```
DWELL TIME
1:00
MM:SS
```

- **PI – Polarization index**

(See 5.2.5.3, pg. 25)

- **DAI – Dielectric absorption index**

(See 5.2.5.4, pg. 26)

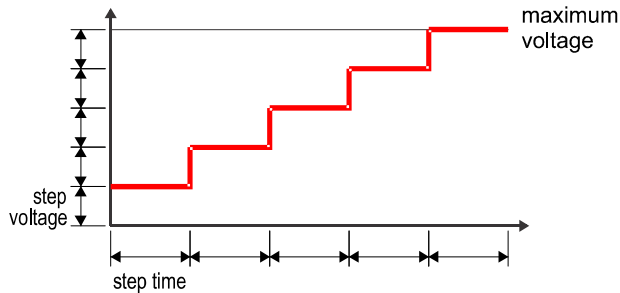

### 5.2.3. Step Voltage Test (SVT)

In this mode of operation, the user does not set a specific test voltage, but rather the values of **maximum voltage**, **voltage step** and **step time value**. The instrument will start the test by applying the value of the voltage step and increase this value at each programmed time interval until it reaches the maximum voltage value. At each stage, the equipment measures the resistance before moving to the next step.



The test result is calculated using the following formula:

$$SVT = \frac{R_{VMAX}}{R_{VMIN}}$$

- Access the device's MENU using the  button.
- Use the control , to select SETUP TEST and press .

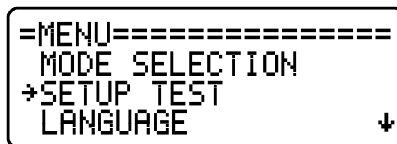

- Use the control , select STEP VOLTAGE TEST and press .

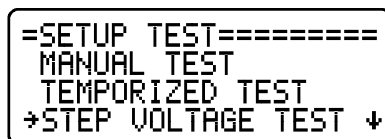

## Parameters

```
=SUT MODE PARAM=====
MINIMUM RESIST.
MAXIMUM VOLTAGE
→STEP VOLTAGE      ↓
TIME STEP
RETURN
```





- **Minimum resistance**

(See 5.2.5.1, pg. 24)

- **Maximum voltage**

(See 5.2.5.2, pg. 25)

- **Step voltage**

Use the control , select STEP VOLTAGE and press . Use  to set the voltage step and press  or  to cancel.

```
STEP VOLTAGE
      100 V
```

- **Time step**

Use the control , select TIME STEP and press . Use  to set the time for each step and press  or  to cancel.

```
STEP DURATION
      1:00
      MM:SS
```

### 5.2.4. Ramp mode

In this mode of operation, the user does not set a specific test voltage, but the values of **maximum voltage** and time value of duration. The instrument will start the test by applying a rising voltage value until the maximum voltage / duration time value is reached.

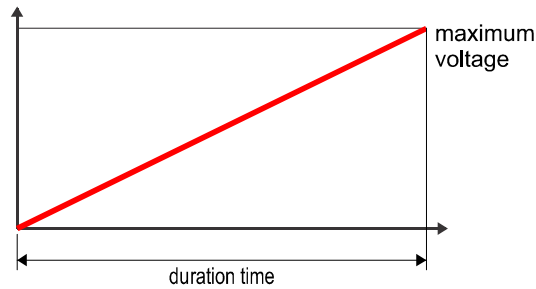

- Access the MENU using the  button.
- Use the control , select SETUP TEST and press .

```

=MENU=====
MODE SELECTION
→SETUP TEST
LANGUAGE                                     ↓
    
```

- Use the control , select RAMP TEST and press .

```

=SETUP TEST=====
TESPORIZED TEST                               ↑
STEP VOLTAGE TEST
→RAMP TEST                                     ↓
    
```

#### Parameters

```

=RAMP MODE PARAM====
MINIMUM RESIST.
→MAXIMUM VOLTAGE
DWELL TIME                                     ↓
RETURN
    
```

- **Minimum resistance**  
(See 5.2.5.1, pg. 24)

- **Maximum voltage**  
(See 5.2.5.2, pg. 25)

- **Dwell time**

Use the control , select DWELL TIME and press . Use  to set the time in minutes and press . Use  to set the time in seconds and press  to confirm or  to cancel.







```
DWELL TIME
      1:00
      MM:SS
```

### 5.2.5. Common parameters





The following parameters are present in almost all measuring modes, however each measurement mode stores its own setting value.

#### 5.2.5.1. Minimum resistance (pass / fail mode)

- This mode allows you to set a minimum resistance value and perform pass / fail test. Use the control , select the MINIMUM RESIST. option and press . Use the control , select the ON option and confirm by pressing .





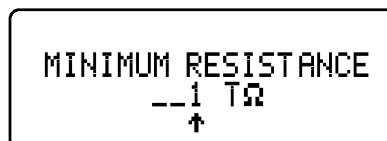

```
=ENABLE MIN RES=====
ON
* OFF
```

Use the , select a value from 1 to 999 and press  button. With the , select the unit (k $\Omega$ , M $\Omega$ , G $\Omega$  or T $\Omega$ ) and confirm with the .



```
MINIMUM RESISTANCE
  --1 TΩ
  ↑
```





### 5.2.5.2. Maximum voltage

- This mode allows you to set a maximum voltage value. With the control , select the MAXIMUM VOLTAGE option and press . With the control , select a value up to 5,000 V. Confirm with  or cancel with .

```

MAXIMUM VOLTAGE
      5000 V
    
```

### 5.2.5.3. PI – Polarization Index

- The polarization index is the quotient between the values of the insulation resistance measured both in the Ra and Rb defined times. This index is useful to detect the damage of the insulation resistance by the excessive presence of dust, dirt and greases or through the action of chemical and physical agents. With the control , select the time value for Ra and press . With the control , select the time value for Rb and press  to confirm or cancel with .

```





=POLARIZATION INDEX=
      PI = Ra / Rb
→Ra: 10 min
Rb: 1 min
    
```



Default values for the polarization index:

$$PI = \frac{R_{10\ min}}{R_{1\ min}}$$

#### 5.2.5.4. DAI – Dielectric absorption index

- The absorption index is the quotient of the resistance values measured at the times defined in Ra and Rb. This index is useful in preventive and predictive maintenance of windings (present in transformers, motors, generators, etc.). With the control , select the time value for Ra and press . With the control , select the time value for Rb and press  to confirm or cancel with .

```
=DIELECTRIC ABSORP.=  
DAI = Ra / Rb  
→Ra: 60 sec  
Rb: 30 sec
```



Standard values for absorption index:

$$DAI = \frac{R_{60s}}{R_{30s}}$$

---



### 5.2.6. Dielectric Discharge

This measurement method is generally used to diagnose multilayer insulation, which requires the instrument to measure the discharge current and the capacitance of the object measured 1 min after the test voltage is removed. This is a very good insulation diagnostic test to detect deterioration and other problems in the multiple insulation to be evaluated.



**Table of reference values for analysis of the DD test result for multilayer insulation**

DD Result	Quality of insulation
> 7	Dangerous
4 - 7	Bad
2 - 4	Dubious
< 2	Good

- Access the MENU using the  button.
- Use the control , select SETUP TEST and press .

```

=MENU=====
MODE SELECTION
+SETUP TEST
LANGUAGE
↓
    
```

- Use the control , select D.D. TEST and press .

```

=SETUP TEST=====
TEMPORIZED TEST ↑
STEP VOLTAGE TEST
RAMP TEST ↓
+D.D. TEST
CAPACITANCE TEST
    
```

### Parameters

- Use the control , select ON to activate or OFF to deactivate the Dielectric Discharge.

### 5.2.7. Capacitance Test

- The capacitance value is obtained by performing an insulation resistance measurement.

Access the MENU using the  button.

Use the control , select SETUP TEST and press .

```

=MENU=====
MODE SELECTION
+SETUP TEST
LANGUAGE                                     ↓
  
```

Use the control , select CAPACITANCE TEST and press .

```

=SETUP TEST=====
TEMPORIZED TEST ↑
STEP VOLTAGE TEST
RAMP TEST ↓
D.D. TEST
+CAPACITANCE TEST
  
```

#### Parameters

Use the control , select ON to activate or OFF to deactivate the Capacitance Test.



Wait for the test to finish. The results screen will appear:

Measured resistance	<pre> R= 19.5 GΩ   0 00:17 U:  498 V   I:24.4 nA DAI:-----  PI:----- CAP: 1.00nF DD:Calc.   </pre>	Duration of the test
Applied voltage		Leakage current
Absorption rate		Polarization index
Capacitance		Dielectric discharge

**NOTE:** The DD test depends on the Capacitance test, ie disabling the Capacitance test also disables the DD test.



## 5.3. Equipment setting

### 5.3.1. Language setting

- Access the device's MENU using the  button.
- Use the control , select the LANGUAGE and press .

```



=====
MODE SELECTION
SETUP TEST
→LANGUAGE          ↓
    
```

- Use the control , select the desired option. Confirm with  or cancel with  button.

```



=====
• ENGLISH
  ESPANOL
  PORTUGUES
    
```

### 5.3.2. Setting the date format

- Access the MENU using the  button, Use the control  select the SETTINGS option and press .



```

=====
LANGUAGE          ↑
→SETTINGS          ↓
MEMORY
    
```

- Use the control , select the SET DATE FORMAT option and press .



```

=====
→SET DATE FORMAT
  SET TIME FORMAT
  DATE ADJUST      ↓
-----
TIME ADJUST
BACKLIGHT
SYSTEM INFO
RETURN
    
```



- Use the control , select the desired option. Confirm with  or cancel with .

```
=DATE FORMAT=====
*MM/DD/YYYY
DD/MM/YYYY
YYYY-MM-DD
```



### 5.3.3. Time Format Setting

- Access the MENU using the , use the control , select SETTINGS option and press .

```
=MENU=====
LANGUAGE          ↑
+SETTINGS
MEMORY           ↓
```



- Use the control , select the SET TIME FORMAT option and press .

```
=SETTINGS=====
SET DATE FORMAT
+SET TIME FORMAT
DATE ADJUST      ↓
-----
TIME ADJUST
BACKLIGHT
SYSTEM INFO
RETURN
```

- Use the control , select the desired option. Confirm with  button or cancel with .

```
=TIME FORMAT=====
* 12 H
24 H
```





### 5.3.4. Setting the date

- Access the MENU using the  button, use the control , select the SETTINGS option and press .

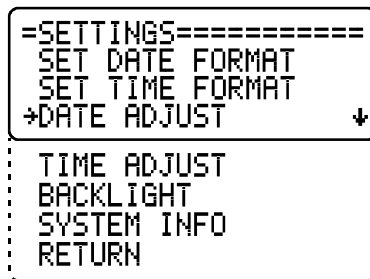

- Use the control , select the DATE ADJUST option and press .



- Use the control , set the DAY and press , set the MONTH and press , adjust the YEAR and confirm with . To cancel the setting press . OBS. The order of the parameters (Day / Month / Year) will be in accordance with the setting defined in Date adjust.

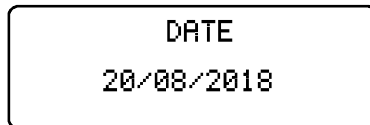

### 5.3.5. Setting the time





- Access the MENU using the  button, use the control , select the SETTINGS option and press .



- Use the control , select the TIME ADJUST option and press .

```

=SETTINGS=====
SET DATE FORMAT
SET TIME FORMAT
DATE ADJUST      ↓
+TIME ADJUST
BACKLIGHT
SYSTEM INFO
RETURN
  
```

- Use the control , set the time and confirm with  button. Adjust the minutes and confirm with  button. To cancel the operation, press  button.

```

      HOUR
    04:29 PM
  
```

### 5.3.6. Selecting the interaction with the backlight

- Access the MENU using the  button, use the control , select the SETTINGS option and press .

```

=MENU=====
LANGUAGE      ↑
+SETTINGS
MEMORY      ↓
  
```





- Use the control , select BACKLIGHT and press .

```

=SETTINGS=====
SET DATE FORMAT
SET TIME FORMAT
DATE ADJUST      ↓
TIME ADJUST
+BACKLIGHT
SYSTEM INFO
RETURN
  
```



- Use the control , select MODE option and press .

```
=BACKLIGHT=====
→MODE
ADJUST
RETURN
```

- Use the control , to select between the TIMED option (the backlight only lights up when the  button is pressed, turning off automatically after 10 seconds) or ON (lit all the time). Confirm with  button or cancel with  button.

```
=MODE=====
TIMED
ON
```

### 5.3.7. Adjust the backlight

- Access the MENU using the , use the control , select the SETTINGS option and press .



```
=MENU=====
LANGUAGE ↑
→SETTINGS
MEMORY ↓
```

- Use the control , select BACKLIGHT and press .

```
=SETTINGS=====
SET DATE FORMAT
SET TIME FORMAT
DATE ADJUST ↓
TIME ADJUST
→BACKLIGHT
SYSTEM INFO
RETURN
```



- Use the control , select ADJUST option and press .

```
=BACKLIGHT=====
MODE
→ADJUST
RETURN
```

- Use the control , adjust the intensity of the backlight. Confirm with  button or cancel with  button.

```
=BACKLIGHT=====
Min■■■■■■-----Max
```

### 5.3.8. Equipment Information

- Access the MENU using the , use the control  to select the SETTINGS option and press .

```
=MENU=====
LANGUAGE          ↑
→SETTINGS
MEMORY           ↓
```

- Use the control  to select the SYSTEM INFO option and press .

```
=SETTINGS=====
SET DATE FORMAT
SET TIME FORMAT
DATE ADJUST      ↓
TIME ADJUST
BACKLIGHT
→SYSTEM INFO
RETURN
```



- The firmware version and serial number of the device will be displayed. Press  to close the screen or  to exit the MENU.

```
=SYSTEM INFO=====
FW.VER.: 00001
S. NUMBER: XX5555A
```



## 5.4. Memory

This device has internal memory for up to 16,000 measurement values. For safety, always download the memory of the equipment to a computer when the tests are finished.

- Access the device's MENU using the  button. Use the control , select the MEMORY option and press .

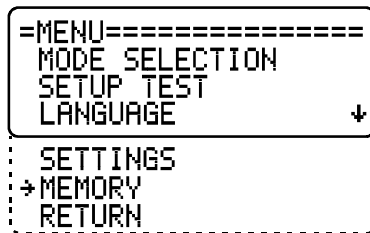



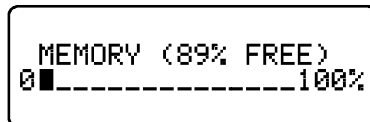

### 5.4.1. Memory usage

- Use the control , select the USAGE option and press .



### 5.4.2. Delete

- Use the control , select the DELETE option and press . A warning message will be displayed. Press  to continue or  to cancel.

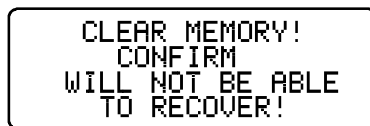

- Use the control , select the YES or NO. Confirm with .



---

## 6. Performing tests



---

**OBS.:** If the resistance to be measured exceeds the maximum limit of the selected voltage this message will be displayed: **R > XXXΩ**.

(see 12. *Technical Specifications*, pg. 47)



---



**ATTENTION:** Please, never connect or disconnect the test leads with the equipment under operation or while the High Voltage led (  ) is on. If there is a need to modify the connections, this should be done with the equipment disconnected and with discharged potentials (High Voltage led  off).

---

### 6.1. Manual Testing

- Access the device's MENU using the  button.
- Use the control , select MODE SELECTION and press .

```
=MENU=====
+MODE SELECTION
  SETUP TEST
  LANGUAGE      ↓
```

- Use the control , select MANUAL TEST and press .









```
=SETUP TEST=====
+MANUAL TEST
  TEMPORIZED TEST
  STEP VOLTAGE TEST ↓
```

- Set the test parameters (see *Setting the measurement modes*, item 5.2.1. *Manual mode*, pg. 19).
- 





The test voltage is the only parameter that can be modified during the test.

---

- Press the V test key  to activate the step voltage adjustment then press one of the voltage adjustment keys ( or ). Select a preprogrammed voltage (, ,  or ) or use  to adjust the voltage value.



- Press  to start the test. The equipment will start applying high voltage and the high voltage LED () will light up. The test number will be displayed and then the measured resistance value:

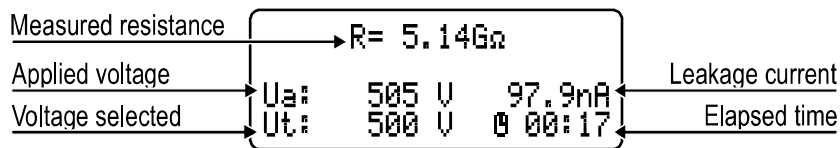

- Press  to complete the test. The results screen will appear:

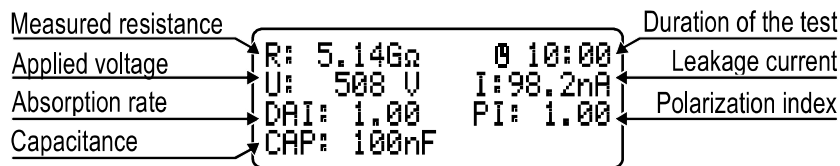



The capacitance value may take a few seconds to be calculated



The maximum continuous measurement time in the manual mode is 95 minutes. After this period, the current test will automatically be finalized (Stop).

## 6.2. "TIMER" Mode

- Access the device's MENU using the  button.
- Use the control , select MODE SELECTION and press .

```

=MENU=====
→MODE SELECTION
  SETUP TEST
  LANGUAGE      ↓
  
```

- Use the control , select TEMPORIZED TEST and press .









```

=SETUP TEST=====
  MANUAL TEST
  →TEMPORIZED TEST
  STEP VOLTAGE TEST ↓
  
```

- Configure the test parameters (see *Setting the measurement modes, item 5.2.2. "TIMER" Mode*, pg. 19).





The test voltage is the only parameter that can be modified during the test.

- Press the V test key  to activate the step voltage adjustment then press one of the voltage adjustment keys ( or ). Select a preprogrammed voltage (, ,  or ) or use  to adjust the voltage value.

```

TEMP          U < 15 U
              Utest: 0.500
RMIN:-----  0 10:00
06/03/2018    12:00
  
```

F53-11

- Press  to start the test. The equipment will start applying high voltage and the high voltage LED () will light up. The test number will be displayed and then the measured resistance value:

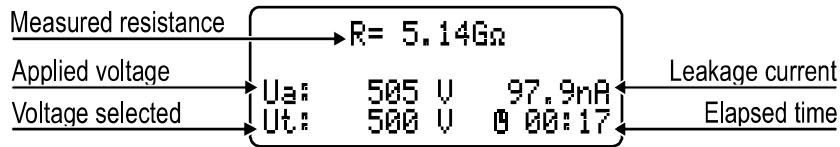

- Wait for the end of the test. The results screen will appear:

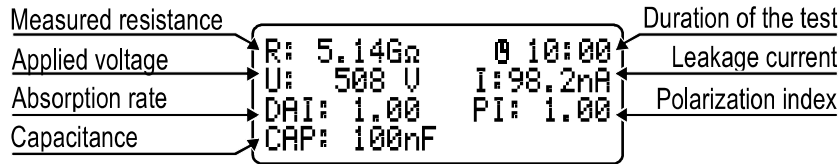

The capacitance value may take a few seconds to be calculated

### 6.3. Step voltage test (SVT)

- Access the device's MENU using the button.
- Use the control , select MODE SELECTION and press .

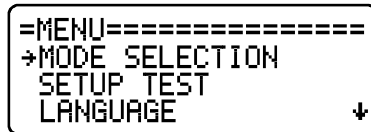

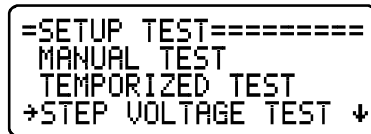

- Use the control , select STEP VOLTAGE TEST and press .

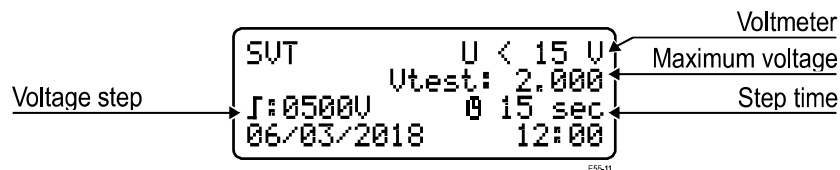

- Set the test parameters (see *Setting the measurement modes, item 5.2.3. Step Voltage Test (SVT), pg. 21*).



- Press  to start the test. The equipment will start applying high voltage and the high voltage LED () will light up. The test number will be displayed and then the measured resistance value:

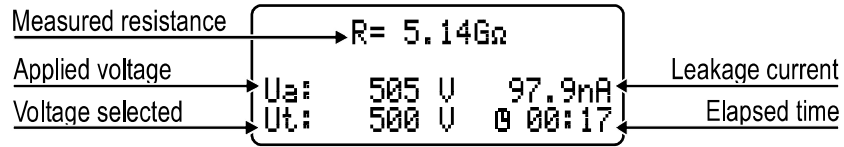

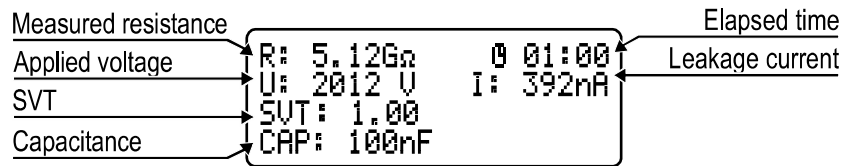

- Wait for the test to finish. The results screen will appear:



The capacitance value may take a few seconds to be calculated

## 6.4. Ramp test

- Access the device's MENU using the  button.
- Use the control , select MODE SELECTION and press .



```
=MENU=====
→MODE SELECTION
  SETUP TEST
  LANGUAGE      ↓
```

- Use the control , select RAMP TEST and press .

```
=SETUP TEST=====
  TEMPORIZED TEST ↑
  STEP VOLTAGE TEST
  →RAMP TEST     ↓
```

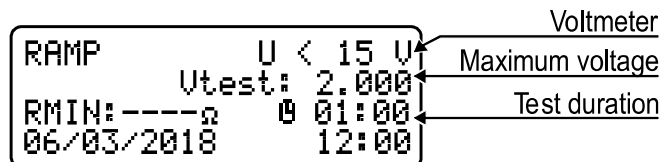
- Configure the test parameters (see *Setting the measurement modes, item 5.2.4. Ramp mode, pg. 23*).



- Press  to start the test. The equipment will start applying high voltage and the high voltage LED () will light up. The test number will be displayed and then the measured resistance value:

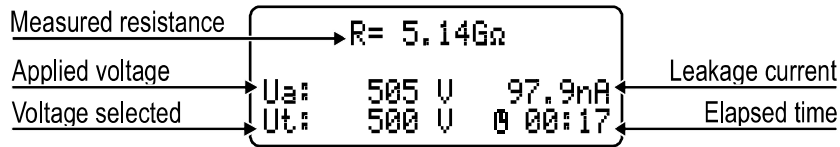

- Wait for the test to finish. The results screen will appear:

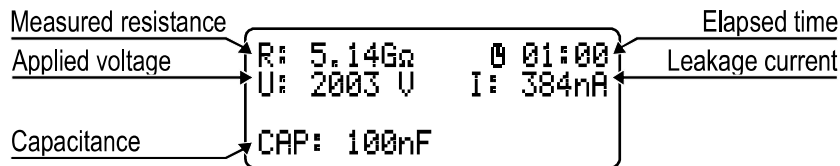

The capacitance value may take a few seconds to be calculated



## 6.5. “Pass / Fail” Test mode

The "pass / fail" test can be performed in any of the measuring modes, simply set the MINIMUM RESISTANCE value of the selected mode (see 5.2.5.1, pg. 24). During this type of test, the equipment will indicate with an intermittent “BEEP” when the insulation resistance is lower than the programmed threshold.

## 7. Other functions

---

### 7.1. Backlight

The equipment display has a backlight. In order to activate it, press  key. After 10 seconds the backlight will auto-turn off. If you want to reactivate it, press  key again.

### 7.2. Filter

When insulation measurements are carried out in transformers or in large dimension machines, in presence of strong electromagnetic fields, it is possible for the equipment reading to be unstable, especially for resistance values higher than 100 MΩ. In these cases it is convenient to press the  key before starting the measurement activating the filter which allows for the reaching of the insulation resistance value in an upward curve without significant oscillation.

### 7.3. True RMS AC/DC Voltmeter

In order to use this function, connect the test points and turn on **PM5A3**. The measured value will be exhibited automatically in the display.

AC	DC
15 V up to 1000 Vr.m.s.	15 V up to 1000 V

Precision:  $\pm$  (5% of the reading + 3 digits)

### 7.4. Leakage current measurement

During the tests, the equipment measures and exhibits in the display the leakage current value within a range of 1 nA up to 3,000  $\mu$ A, with a Precision of  $\pm$  (10% of the reading + 3 digits).

### 7.5. Hold

This function allows holding the last performed reading on the display at the moment when pressing the  key, without interrupting the test. When this key is pressed again, the equipment updates the resistance



and chronometer values. The led of  key and the letter **H** on the display indicate that the function has been activated

## 7.6. Battery status check

Hold the  key pressed in order to check the battery status during measurements. The analogue bargraph will give an approximate visual representation of the remaining charge percentage; additionally, the display will show the message “**Battery OK**” if the charge is enough, or “**Battery Low**” if the charge is low. In this last case, it is highly advisable to charge the battery before using the apparatus. If battery charge is under 20% of the total, the message **Battery Low** will automatically appears on the display.

## 7.7. Auto power-off

The **PM5A3** auto-turns off after 10 minutes of inactivity.

## 8. Software

### 8.1. USB Drivers

To install the USB drivers required for the communication between PC and equipment follow the instructions:

1. Connect the equipment in the PC using the USB cable.
2. If there is an available Internet connection, Windows will silently connect to the Windows Update website and install any suitable driver it finds for the device. If no suitable driver is automatically found then you need to insert the CD-ROM, supplied with the equipment, in the PC, run the executable “usb-install.exe” and click in “Install”.

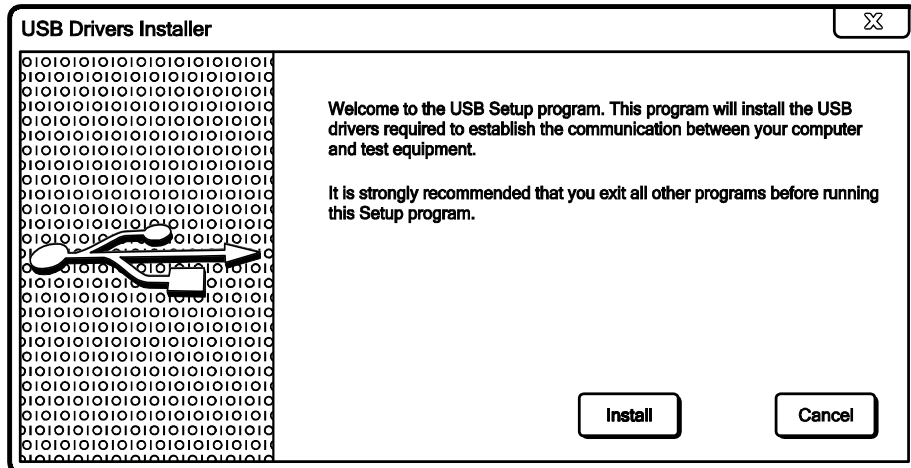

### 8.2. PXLogger software

This software makes communication between the equipment and a computer with Windows operative system easier. It makes it possible to synchronize the date and time of the equipment internal clock with the computer date and clock, to transfer the stored date, to clear the memory, to generate test reports, etc. The installation and operation instructions are included in the software.

## 9. Remote control

The Phenix equipment that have Bluetooth interface can be controlled remotely via an Android device (smartphone / tablet) running the application.

### Pairing

To perform the pairing between equipment and the Android device, follow the procedure:

- To enable the Bluetooth, in screen "Applications", tap "Settings" > "Bluetooth" and drag the Bluetooth slider to the right.
- To pair your equipment, on screen "Applications", tap "Settings" > "Bluetooth" > "Search". Select the equipment and wait for the end of the pairing (If necessary, accept the automatically generated password to confirm or enter the PIN 1234).

---

## 10. Printer

---

In order to enable the printing function press  key. Measured values will be printed each 15 seconds. Printing may be started or stopped at any time during the test. However, it is convenient to turn the printer on before starting the test in order to print it complete, including the heading.

---

**ATTENTION:** Don't pull the paper. The printer can be easily damaged.

---

This printer uses 57 mm-wide thermal paper, which comes in a 30 mm-diameter reel.

---

### Precautions



- Perform the procedures below with the equipment turned off.
  - Disconnect the equipment from the mains supply and remove the power cord.
  - Disconnect the test leads.
- 

- 1 Pull the lever located on the lid.
- 2 Insert the paper reel as shown in the figure.
- 3 Keep the tip of the paper out of the printer and close the lid.

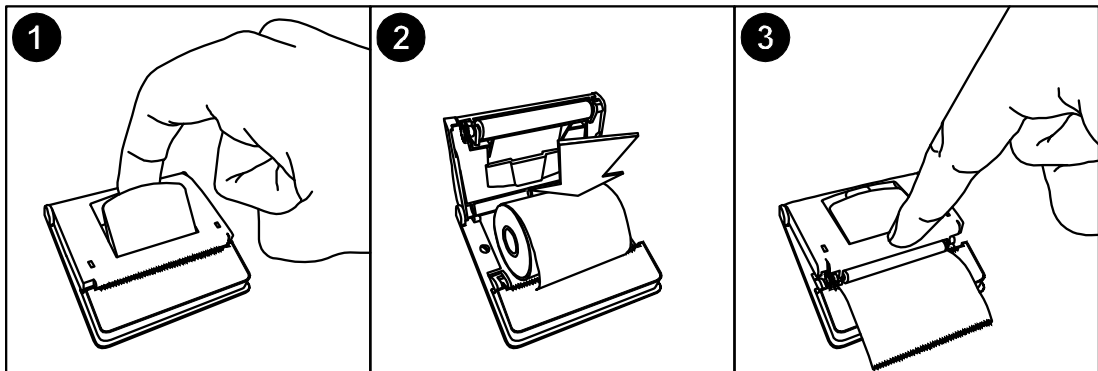

---

## 11. Cleaning

---

The panel, terminals and connectors of the equipment must stay dry and clean. Cleaning should be made using a wet cloth in water and a soft detergent or isopropyl alcohol (be sure that the products to be used for cleaning does not affect plastic goods).

## 12. Technical Specifications

---

<b>Test voltages</b>	:	500 V, 1,000 V, 2,500 V, 5,000 V with fast selection. Other test voltages from 50 V to 5 kV, can be selected in steps of 25 V or 500 V. DC, negative in relation to grounding.
<b>Terminal output max value</b>	:	5,100 V.
<b>Maximum resistance reading</b>	:	5 T $\Omega$ @ 5 kV. 1 T $\Omega$ @525 V up to 999 V. 500 G $\Omega$ @500 V. 250 G $\Omega$ @ 250 V.
<b>DC Voltmeter</b>	:	15 V up to 1,000 Vdc. Precision: $\pm$ (5% of the reading + 3 digits)
<b>AC voltmeter</b>	:	15 V up to 1,000 V r.m.s. Precision: $\pm$ (5% of the reading + 3 digits)
<b>Over voltage protection</b>	:	CAT. III – 600 V.
<b>Current measurement</b>	:	1 nA up to 3,000 $\mu$ A. $\pm$ (10% of the reading + 3 digits)
<b>Capacitance measurement</b>	:	50 nF up to 10 $\mu$ F @ 500 V. 50 nF up to 5 $\mu$ F @ 1,000 V. 30 nF up to 2 $\mu$ F @ 2,500 V. 30 nF up to 1 $\mu$ F @ 5,000 V. Precision: $\pm$ 10% of the reading $\pm$ 3 digits
<b>Short circuit current</b>	:	Max. 3 mA.
<b>Test voltages accuracy</b>	:	$\pm$ 3% of nominal value over on 10 G $\Omega$ resistance.

<b>Equipment accuracy</b>	: ±5% of reading between 1 MΩ and 1 TΩ @ 5 kV. ±20% of reading between 1 TΩ and 5 TΩ @ 5 kV. (For lower test voltages, the superior limit is proportionally reduced) ± 20% of reading ± 5 digits from 10 kΩ to 100 kΩ. ± 10% of reading ± 5 digits from 100 kΩ to 1 MΩ.
<b>Advanced features</b>	: <ul style="list-style-type: none"><li>• Ramp test.</li><li>• Dielectric discharge.</li><li>• Step voltage test.</li><li>• Automated Polarization Index computing.</li><li>• Automated Dielectric Absorption Index computing.</li><li>• “Pass-fail” and fixed time tests.</li><li>• Step Voltage Test.</li><li>• Memory for up to 16000 measurements.</li><li>• Filter to minimize interferences.</li></ul>
<b>Printer</b>	: Prints elapsed time, actual voltage applied to the element under test and measured resistance.
<b>PC Interface</b>	: USB.
<b>Built-in chronometer</b>	: Indicates elapsed time from the beginning of the measurement mm:ss format.
<b>Environmental protection index</b>	: IP65 (with closed lid).
<b>Safety</b>	: In accordance with IEC 61010-1.
<b>Electromagnetic compatibility (E.M.C.)</b>	: In accordance with IEC 61326-1.
<b>Electromagnetic irradiation immunity</b>	: In accordance with IEC 61000-4-3.

<b>Electrostatic immunity</b>	:	In accordance with IEC 61000-4-2.
<b>Power supply</b>	:	Internal rechargeable battery LiFePO4 12 V - 6 Ah.
<b>Battery charger</b>	:	12 V - 2 A.
<b>Operating temperature</b>	:	23 °F to 122 °F (-5 °C to 50 °C).
<b>Storage temperature</b>	:	-13 °F to 158 °F (-25 °C to 70 °C).
<b>Humidity</b>	:	95% RH (non condensing).
<b>Altitude</b>	:	Up to 5,000 m.
<b>Equipment weight</b>	:	Approx. 9.48 lb (4.3 kg).
<b>Dimensions</b>	:	13.6" x 10.8" x 7.7" (345 x 272 x 159 mm).
<b>Supplied accessories</b>	:	<ul style="list-style-type: none"><li>• 3 measurement cables</li><li>• AC Adapter</li><li>• Cable for USB</li><li>• Carrying bag</li><li>• Operation manual</li><li>• License for PXLogger software</li></ul>

Subject to technical change without notice.

## 13. Application note 32

### Use of “Guard” terminal in insulation testers

When insulation resistance measurements are performed with insulation testers, especially with high sensitivity instruments measuring high resistance values, the use of the *GUARD* terminal avoids the harmful influence of stray resistances.

In order to better explain the function of this terminal, let us start reviewing the insulation tester basic circuit diagram of fig. 1.

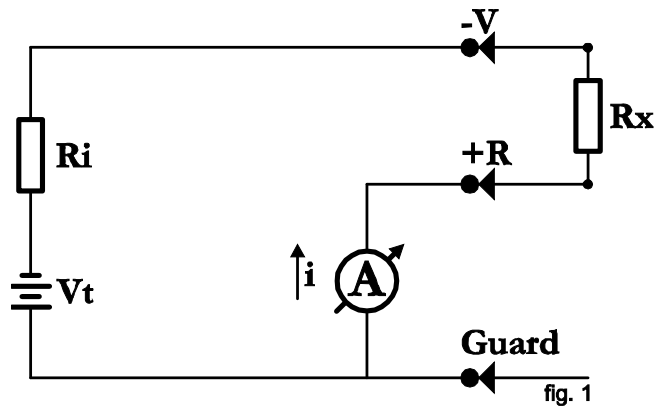

Where:

- $V_t$  : DC high-voltage generator
- $R_i$  : Generator internal resistance
- $A$  : Indicator meter (micro-ammeter)

The unknown resistance ( $R_x$ ) is connected between  $V$  and  $R$  terminals. Its value determines the current passing through the circuit, which in turn is indicated by the micro-ammeter. The value of  $R_x$  can be determined as follows:

$$R_x = \frac{V}{i} - R_i$$

In many cases the resistance to be measured is in parallel with other stray resistances which influence on  $R_x$  should be minimized.



A typical example of this situation is when the insulation resistance between primary and secondary windings of a transformer mounted inside a metal housing is to be measured.

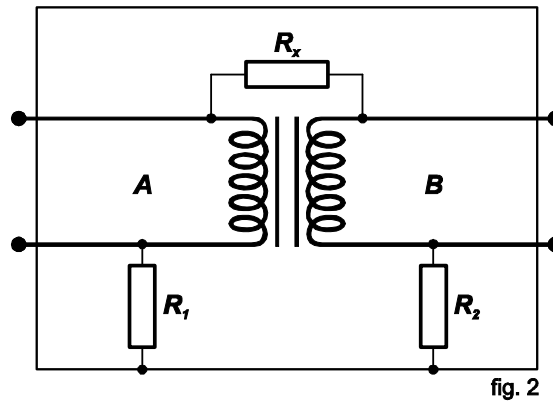

fig. 2

- R<sub>x</sub>: Insulation resistance between primary and secondary winding.
- R<sub>1</sub>: Insulation resistance between primary winding and housing.
- R<sub>2</sub>: Insulation resistance between secondary winding and housing.

If the insulation tester (terminals V and R) is connected to transformer terminals A and B, and considering that the resistance of the coils on each side of the transformer may be disregarded,  $R_x$  appears to be in parallel with  $(R_1 + R_2)$ . The situation is changed if we connect the transformer housing to GUARD terminal. Then the circuit will be:

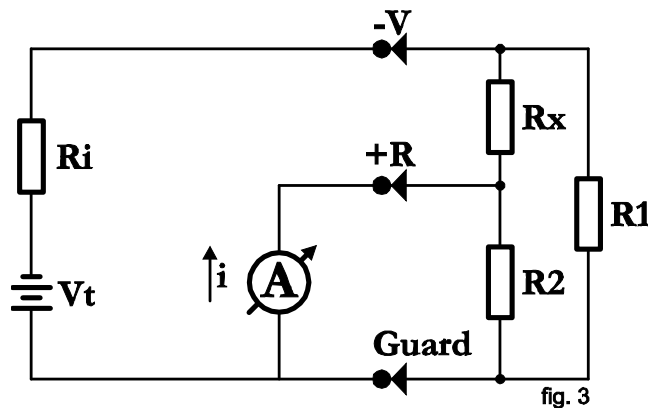

fig. 3

In the circuit of Fig. 3 it may be noted that R1 is in parallel with a low-value resistance (the one from the micro-ammeter) therefore its influence is reduced during reading.

Through resistance R2 circulates a current which is not passing through the meter and consequently does not affect the reading. In fact, current through R2 originates a certain error, since it creates an additional voltage drop in R1 which was not regarded during equipment calibration. As regards the practical use of instrument, it shall be considered that if R1 and R2 are higher than 100 M $\Omega$ , any value of Rx will be measured with an insignificant error. For example: Let us consider Rx = 3000 M $\Omega$  and R1 = R2 = 100 M $\Omega$ , the reading without using the GUARD terminal would be 187.5 M $\Omega$ , which is quite wrong. On the other hand, if the GUARD terminal is properly used, we would have 3000 M $\Omega$ .

Notes

---

## Notes

---